

FLASH XTRACTOR

SUB-SURFACE FLOOD EXTRACTION TOOL

AC005



Water Claw
4282 South 590 West
Salt Lake City, UT
84123
801-268-2673
801-268-3856 FAX



INTRODUCTION

Congratulations on your purchase of the Flash Xtractor. The Flash Xtractor is designed to give superior water removal performance when used with portable or truck mounted extractors. Years of experience, engineering, and planning have gone into the design and manufacturing of the Flash Xtractor. We take a great deal of pride in the Flash Xtractor; our goal is no less than your complete satisfaction.

Extraction is the most efficient method of removing water in structural flooding situations.

The subsurface extractors are designed for water removal on carpet and pad, without removing the pad. On glue down carpet installed without pad, the Flash Xtractor is less productive.

The superior water removal achieved using the Flash Extractor will make your other drying methods more affective and speed the drying process.

This manual will provide users with the knowledge to operate and maintain the Flash Xtractor to ensure maximum water removal.

Any questions pertaining to the operating or servicing of this unit should be directed to your nearest Water Claw distributor.

This manual is written specifically for the Flash Xtractor tool manufactured by:

Water Claw
4282 South 590 West
Salt Lake City, UT 84123
801-268-2673
801-268-3856 FAX

Information in this manual is subject to change without notice and does not represent a commitment on the part of Water Claw, its parent or affiliated companies.

SPECIFICATIONS

Model AC005 Flash Xtractor:

Base Dimensions: 16.5" x 9.5" (41.9cm x 24.1cm)

Handle Height: Minimum: 25.5" (64.8cm) Maximum: 38.0" (96.5cm)

Weight: 6.3 lbs. (2.9 kg)

Base Construction: Glass fiber Reinforced ABS

Top Plate Construction: Polycarbonate

Handle Construction: Stainless Steel

ASSEMBLING THE FLASH XTRACTOR

1. Remove the locking Pin (NM5514) from the handle base of the Flash Xtractor.
2. Place the T-Handle into the base and align the lower spring buttons with the holes in the base so the buttons snap into the holes.
3. Align the bottom holes on the handle with the bottom holes on the base and insert the locking pin.

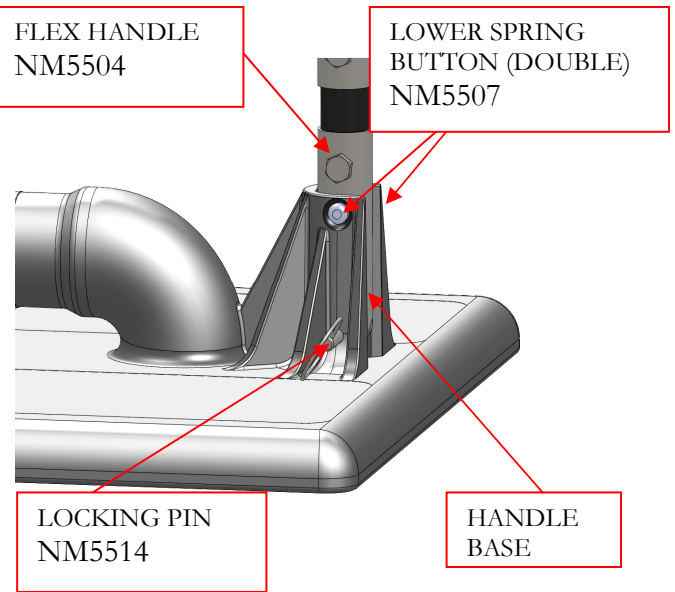

4. Push in the upper spring button in and pull the handle up until the pins snap into the desired hole to adjust the handle height for comfortable operation.

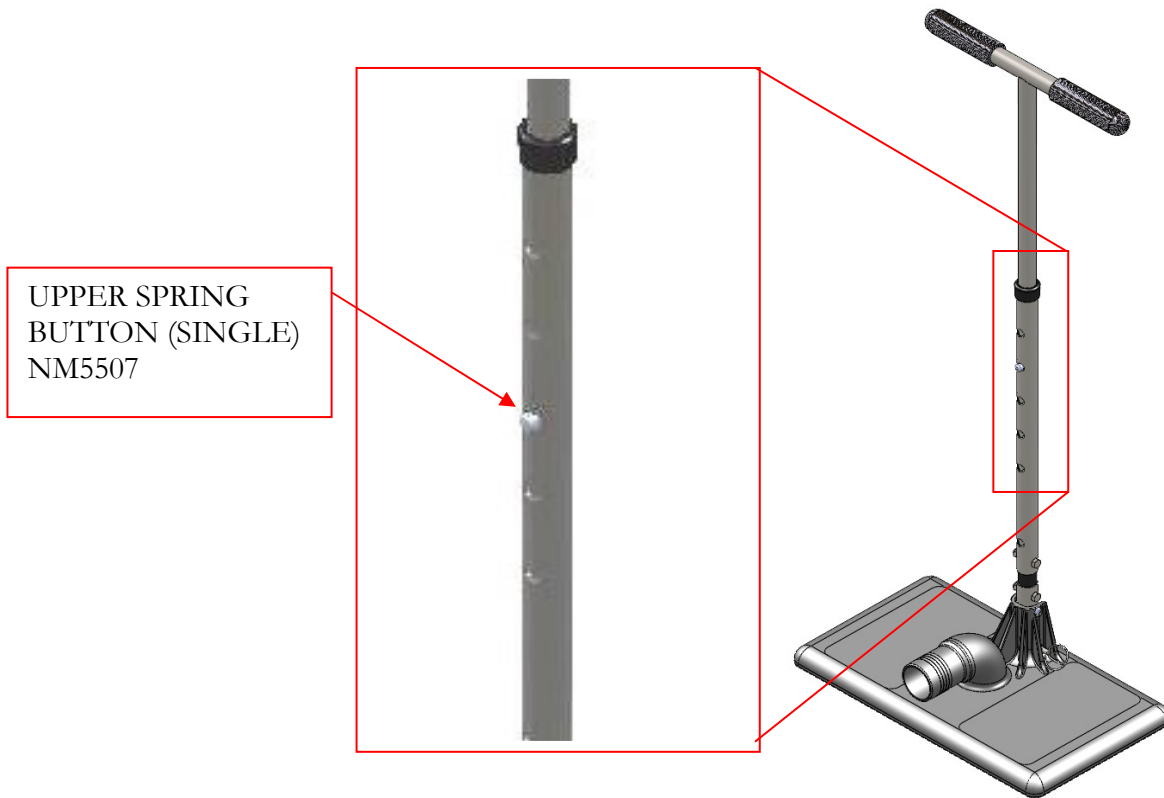

USING THE FLASH XTRACTOR

Extraction Equipment

The Flash Xtractor will work with portable or truck mounted extractors.

The higher air flow of truck mounted extractors will allow your Flash Xtractor to extract more water, faster. When using a portable extractor, if you slow down to allow the tool to extract more water you will still get excellent results.

Do not bend the flexible handle more than 30-45 degrees. Excessive bending will damage the handle and voids the warranty.

Extraction Procedure

1. Connect the vacuum hose from your extractor to the barb on the Flash X-Tractor. A 2" cuff will fit over the barb, a 1-1/2" cuff will fit inside the barb.
2. Turn the extractor ON.
3. If there is standing water place the Flash Xtractor in the center of the room to remove the standing water down to the carpet level. When the standing water has been removed, place the Flash Extractor in the desired starting point, usually in a corner of the room, and stand on top of the Flash Xtractor. After approximately 5-10 seconds, the majority of the water will be removed. Continued extraction from 10 - 30 seconds may remove more water, however by 30 seconds any additional extraction time produces little or no increase in removal. The exact time between position changes can be determined by watching the flow rate of the water being extracted and moving when the flow diminishes. When ready, step off of the Flash Xtractor and move to the next position. The movement to the next extraction position can be to the side, forward or back. The new position should be adjacent to but not overlapping the previous extraction position. Repeat the movement and extraction procedure until you have covered the entire area to be extracted.
4. After you have completed your extraction pass over the entire area, disengage a portion of the carpet in the area being extracted and test the pad to determine if additional extraction is required. Squeeze the pad. If you can squeeze out any water, you need to make another pass over the area with your Flash Xtractor. Repeat test and extract more as needed. When in doubt, extract again.

- A standard carpet wand can be used with your extractor to remove any residual water remaining on the carpet face fibers.

Extracting the water from the carpet & pad using your Flash Xtractor is only part of the drying process. Consult you Omni Pro Restoration distributor for information about training and equipment required for proper water damage restoration.

**A. FRONT TO BACK
EXTRACTION PATTERN**

| | | | |
|---------------|---|---|-----|
| START HERE | → | ↓ | END |
| ↓ | ↑ | ↓ | ↑ |
| ↓ | ↑ | ↓ | ↑ |
| ↓ | ↑ | ↓ | ↑ |
| ↓ | ↑ | ↓ | ↑ |
| ↓ | ↑ | ↓ | ↑ |
| → | ↑ | → | ↑ |

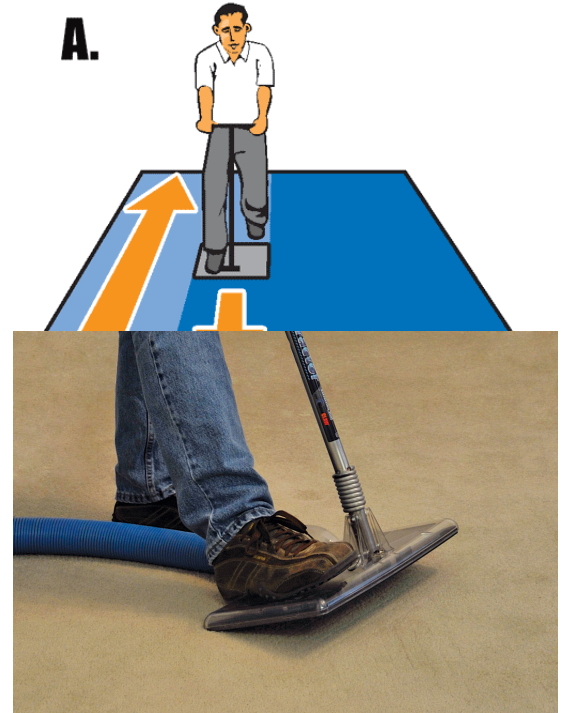

**B. SIDE TO SIDE
EXTRACTION PATTERN**

| | | | |
|---------------|---|---|-----|
| START HERE | → | → | ↓ |
| ↓ | ← | ← | ← |
| → | → | → | ↓ |
| ↓ | ← | ← | ← |
| → | → | → | ↓ |
| ↓ | ← | ← | ← |
| → | → | → | END |

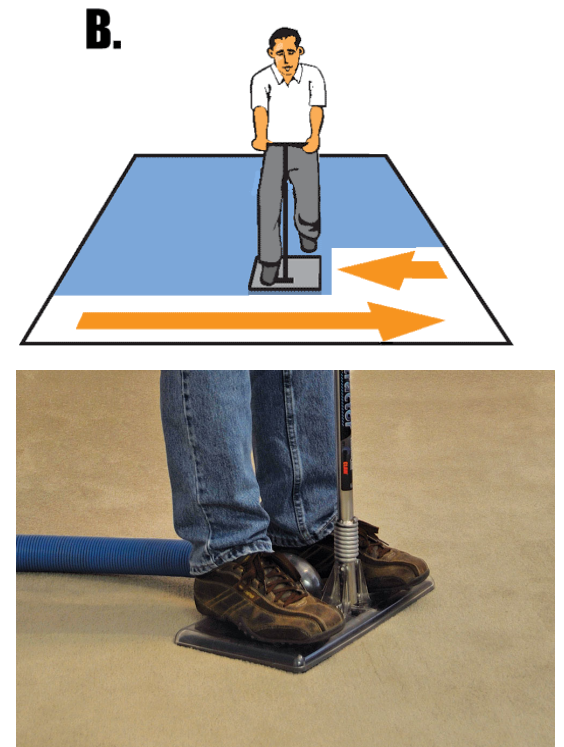

MAINTENANCE

Your Flash Xtractor requires very little maintenance. To keep your Flash Xtractor looking and working its best for the longest period of use:

- Do not bend the flexible handle more than 30-45 degrees.
- Rinse the Flash Extractor after use, wipe down and let dry.
- Examine the vacuum slot and remove debris as needed.

If an excessive amount of debris has been lodged in the slot or is caught in the base assembly, the bottom can be removed from the top of the base. Insert a small screwdriver into the slots on the side of the Flash Extractor. Push in the tabs and pry the bottom away from the top. Clean out the debris and snap the bottom back onto the base top.

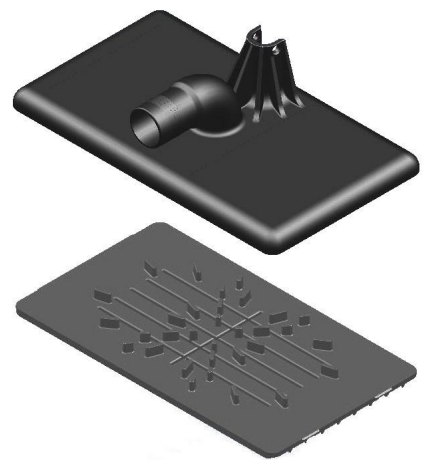

The handle of the Flash Xtractor can be laid flat for storage by pressing in the lower snap buttons and tilting the handle back away from the base. The handle can be removed by removing the locking pin holding the handle to the base.



The Flexible Handle of the Flash Extractor was designed with some flexibility, but not made to handle excessive bending.

Excessive bending will damage the handle. Handle damage from excessive bending is not covered by the Flash Xtractor

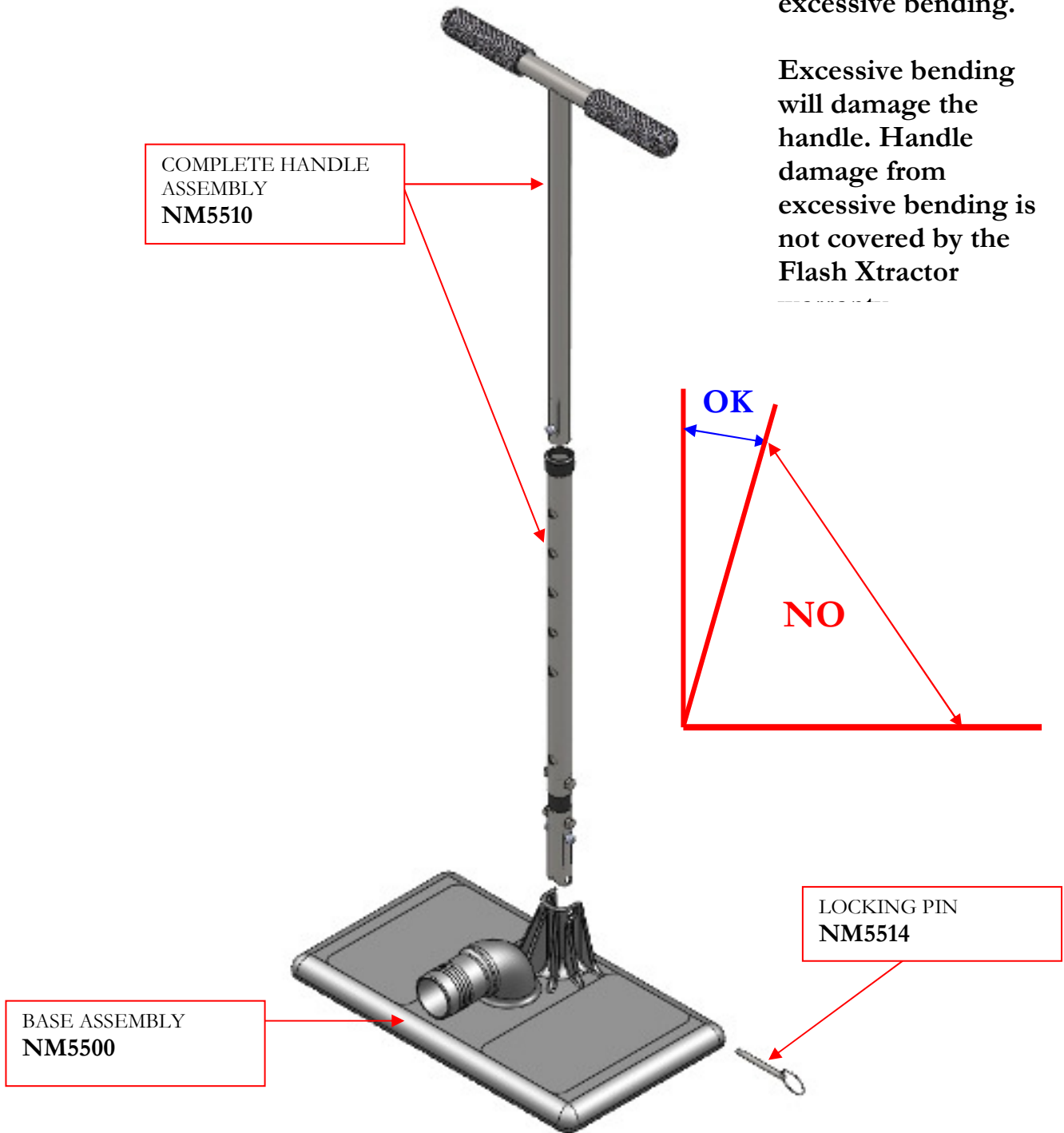

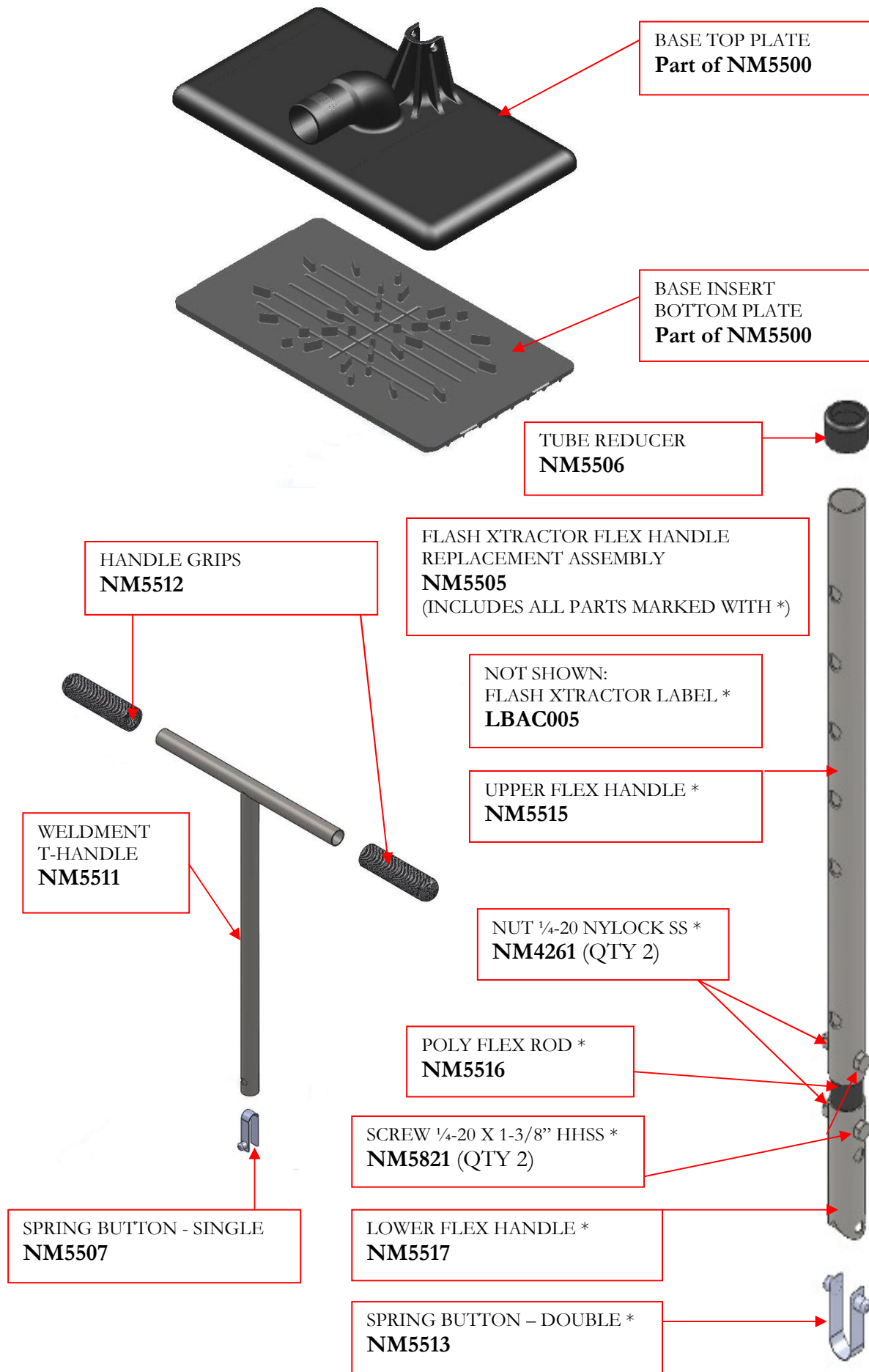

LIMITED WARRANTY

Your Flash Xtractor is designed to give you years of reliable service. If a problem should arise use the troubleshooting section in the operation manual to diagnose and correct the problem if possible.

If you are unable to determine the cause or solution to the problem contact your distributor or Water Claw for assistance.

Water Claw warrants the Flash Xtractor to be free from defects in material or workmanship for two years from the date of purchase.

During the warranty period, Water Claw will, at its option repair or replace components which prove to be defective. This warranty does not provide for replacement of complete units due to defective components. Any costs for transportation or related service labor are not covered in this warranty. Replacement parts are warranted only for the remainder of the original warranty period.

This warranty shall not apply to defects resulting from improper operation, lack of maintenance, unauthorized modification, chemical incompatibility, misuse, abuse or exposure to freezing temperature conditions. It does not apply to items which require replacement as a result of ordinary usage.

To obtain warranty service for the Flash Xtractor, contact your distributor or Water Claw. If the tool must be returned to Water Claw or an authorized service center, the purchaser shall prepay shipping charges for products returned for warranty service. No returned items will be accepted by Water Claw without prior authorization. All returns must have a return authorization number, issued by Water Claw, clearly marked on the exterior of the package.

Water Claw makes no other warranty either expressed or implied with respect to this product.

The remedies provided herein are the purchaser's sole and exclusive remedies. In no event shall Water Claw be liable for any direct, indirect, special, incidental or consequential damages.

This warranty gives you specific legal rights. You may also have other rights which vary from jurisdiction to jurisdiction.